

BEKO

installation & operating instructions and drying guidance Condenser Sensor Dryer

Dry & Save
DPU 8360 W



*get the **best** from your new tumble dryer*

Please read this user manual first!

Dear Customer,

We hope that you get the best results from the product which has been manufactured in state-of-the-art plants and passed through a strict quality control procedure. Therefore, please read the entire user manual carefully before using the product and keep it as a reference for future use. In case of transferring the product to someone else, give the manual as well.

The user manual will help you use your product in a fast and safe way.

- Read the user manual before installing and starting your product.
- Always follow the safety instructions.
- Keep this user manual within easy reach for future reference.
- Read also the other documents supplied with the product.

Remember that this user manual is also applicable for several other models. Differences between models will be identified in the manual.

Explanation of symbols

Throughout this user manual the following symbols are used:

 Read the instructions.

 Important information or useful hints about usage.

 Warning for hazardous situations with regard to life and property.

 Warning for electric shock.

 Warning for fire hazard.

 Warning for hot surfaces.

2960310462_EN/260911.1754



This appliance's packaging material is recyclable. Help recycle it and protect the environment by dropping it off in the municipal receptacles provided for this purpose. Your appliance also contains a great amount of recyclable material. It is marked with this label to indicate the used appliances that should not be mixed with other waste. This way, the appliance recycling organised by your manufacturer will be done under the best possible conditions, in compliance with European Directive 2002/96/EC on Waste Electrical and Electronic Equipment. Contact your town hall or your retailer for the used appliance collection points closest to your home. We thank you doing your part to protect the environment.

TABLE OF CONTENTS

1 Dryer	4
Overview	4
Technical specifications	5
2 Important safety instructions	6
General safety	6
Intended use	8
Children's safety	8
3 Installation	9
Appropriate installation location	9
Removing the transportation safety assembly	9
Under counter installation	9
Mounting over a washing machine.....	10
Connecting to the drain	10
Adjusting the feet.....	10
First use	11
Disposing of packaging material	11
Transportation of the product.....	11
Disposing of the old product.....	11
Warnings about sounds.....	11
4 Electrical Connection	13
Attention!.....	13
Electrical requirements.....	13
Fitting a different plug	13
Washer/dryer combination.....	14
5 Preparations for drying	15
Things to be done for energy saving ..	15
Laundry suitable for drying in the machine	15
Laundry unsuitable for drying in the machine	15
Preparing laundry for drying.....	16
Correct load capacity	16
Loading the laundry	16
6 Selecting a Programme and Operating Your Machine	18
Preparing the machine.....	19
Programme selection.....	19

Main programmes	19
Additional programmes	19
Auxiliary functions.....	22
Warning symbols.....	22
Starting the programme.....	24
Progress of programme.....	24
Child-proof Lock.....	24
Changing the programme after it has started.....	24
Cancelling the programme.....	25
End of programme	26

7 Maintenance and cleaning 27

Lint Filter / Loading Door Inner Surface	27
Cleaning the sensors	27
Draining the water tank.....	28
Cleaning the filter drawer	28
Cleaning the evaporator.....	30

8 Troubleshooting 31

9 Guarantee 33

What is covered?.....	33
What is not covered?.....	33
Important notes	33

10 Service 34

1 Dryer

Overview

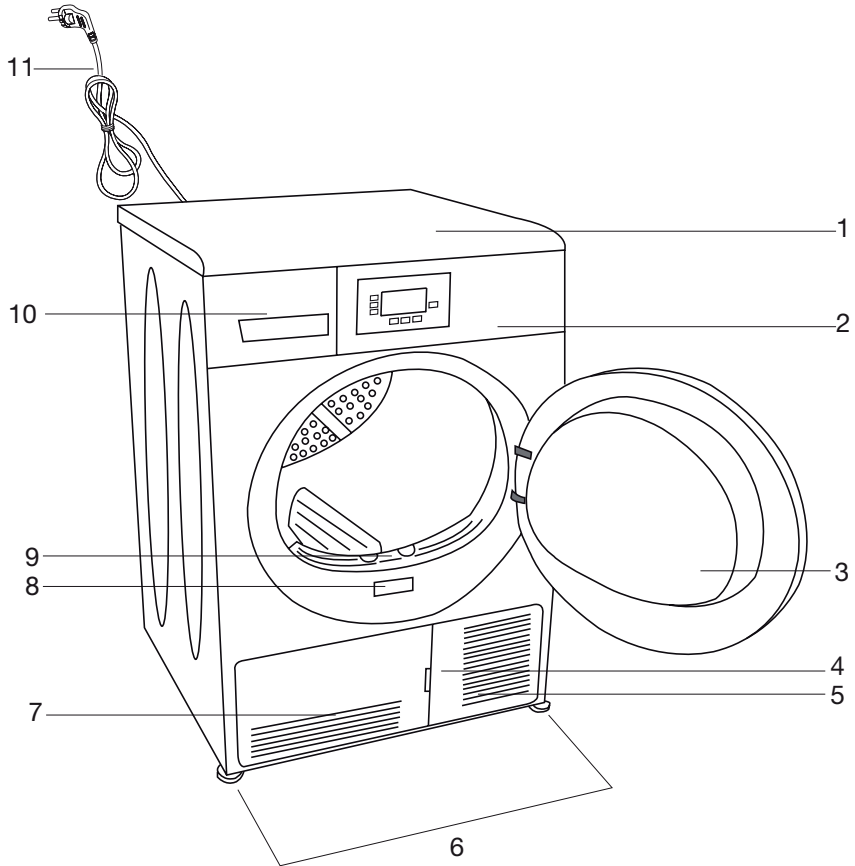

- | | |
|---------------------------|-----------------------|
| 1. Top panel | 7. Kick plate |
| 2. Control panel | 8. Type label |
| 3. Loading door | 9. Lint filter |
| 4. Kick plate opening tab | 10. Water tank drawer |
| 5. Ventilation grids | 11. Power cable |
| 6. Adjustable feet | |

Technical specifications

Height (adjustable)	84.6 cm
Width	59.5 cm
Depth	59.8 cm
Capacity (max)	8 kg
Weight (net)	49 kg
Voltage	See type label
Power	
Main Model Code	

Type label is behind the loading door.

Specifications of this appliance may change without notice to improve the quality of the product. Figures in this manual are schematic and may not match your product exactly.

Values stated on the machine labels or in the documentation accompanying it are obtained in laboratory in accordance with the relevant standards. Depending on operational and environmental conditions of the appliance, values may vary.

2 Important safety instructions

This section contains safety instructions that will help protect from risk of personal injury or property damage. Failure to follow these instructions shall void any warranty.

General safety

- Never place the product on a carpet-covered floor; otherwise, lack of airflow beneath the machine will cause electrical parts to overheat. This will cause problems with your product.
- Do not operate the product if the power cable / plug is damaged. Call the Authorized Service Agent.
- Do not make any changes on the plug supplied with the product. If it is not compatible with the socket, have a qualified electrician change the socket with a suitable one.
- Never touch the plug with wet hands! Never unplug by pulling on the cable, always pull out by grabbing the plug.
- Connect the product to a grounded outlet protected by a fuse of suitable capacity as stated in the technical specifications table.
- Power cable of this product is equipped with a conductor and a grounding plug that allows for grounding the product. This plug must be inserted into a socket which is installed and grounded in accordance with the local laws and regulations. Grounding installation decreases the risk of electric shock by opening a path with low resistance for the electricity flow in case of a malfunction or failure. Do not neglect to have the grounding installation made by a qualified electrician. If you have any suspect about the grounding installation, have it checked by a qualified electrician or the Authorized Service Agent. Our company shall not be liable for any damages that will arise when the product is used without grounding in accordance with the local regulations.
- The product should not be plugged in during installation, maintenance, cleaning and repair works.
- Always have the repair procedures carried out by the Authorized Service Agent. Manufacturer shall not be held liable for damages that may arise from procedures carried out by unauthorized persons.
- Do not use electrical devices in the product.
- You must provide enough ventilation in order to prevent gases exiting from devices operating with other types of fuels including the naked flame from accumulating in the room due to the back fire effect.
- Items cleaned or washed with gasoil/fuel oil, dry-laundry solvents and other combustible or explosive materials as well as the items that are contaminated or spotted with such materials should not be dried in the product since they emit flammable or explosive vapor.
- Do not dry the laundry cleaned with industrial chemicals in the dryer.
- Underwear that contains metal reinforcements should not be dried in the dryer. Dryer can get damaged if metal reinforcements come loose and break off during drying.
- Never attempt to repair the product yourself. Do not perform any repair or replacement procedures on the product even if you know or have the ability to perform the

required procedure unless it is clearly suggested in the operating instructions or the published service manual. Otherwise, you will be putting your life and others' lives in danger.

- For failures that you cannot remedy by applying the procedures in safety instructions, turn off and unplug the product and call the Authorized Service Agent.
- Do not reach into the machine when the drum is spinning.
- Do not use extension cords, multi-plugs or adaptors to connect the dryer to power supply in order to decrease the risk of fire and electric shock.
- Never wash the product by spreading or pouring water onto it! There is the risk of electric shock!



The final step of the drying programme, namely the cool-down step is performed without applying heat to ensure that the laundry items are kept at a temperature that will not damage them. If you open the loading door before the cool-down step completes, hot vapour will come out.



Never stop the dryer before the programme completes. If you must do this, remove all laundry quickly and lay them out to a suitable place to dissipate the heat.

- Always clean the lint filter before or after each loading. Never operate the dryer without the lint filter installed.
- Clean ventilation grid of the product regularly. Do not allow fibre, dust and dirt accumulation around the ventilation grid and at adjacent areas.
- Power cable plug must be within easy reach after installation.
- Do not dry unwashed items in the

dryer.

- Items soiled with cooking oils, acetone, alcohol, fuel oil, kerosene, stain removers, turpentine, paraffin and paraffin removers must be washed in hot water with plenty of detergent before being dried in the dryer.
- Garments or pillows bolstered with rubber foam (latex foam), bathing caps, water resistant textiles, materials with rubber reinforcement and rubber foam pads should not be dried in the dryer.
- Do not use fabric softeners and anti-static products unless they are recommended by the manufacturers of the relevant product.
- Use softeners, anti-static products and etc. in accordance with the instructions of their manufacturers.
- Do not install the product behind a door with a lock, sliding door or a hinged door which can strike the product.
- Do not install or leave the dryer in places where it will be exposed to outdoor conditions.
- Your product can be operated at temperatures between +5°C and +35°C. If the operating conditions fall outside of this range, operation of the product will be adversely affected and it can get damaged.
- Do not tamper with the controls.
- Unplug the product when it is not in use.
- Remove the loading door of the drying compartment before decommissioning or disposing of the product.
- Check all garments before loading and make sure that there is no any lighters, coins, metal pieces, needles, and etc. in their pockets or on them.

- Make sure that the pets do not enter into the product. Check the drum of the product before using it.
- Make sure that original spare parts and accessories are used during maintenance works.
- Do not lean on the loading door when it is open. The product may tip over.
- When your machine is not in use or when you unload the laundry after completion of drying process, turn the machine off with the On/Off button. In cases where the On/Off button is in On position (while the machine is energized), keep the loading door closed.

to children. Keep the packaging materials out of reach of children or dispose them by classifying according to waste directives.

Intended use

- This product has been designed for domestic use. It should not be used for other purposes.
- Product must only be used for drying of textiles that are marked accordingly.
- Dry only those articles in your product that are stated in this manual.
- This product is not intended to be used by persons with physical, sensory or mental disorders or unlearned or inexperienced people (including children) unless they are attended by a person who will be responsible for their safety or who will instruct them accordingly for use of the product.

Children's safety

- Electrical products are dangerous for the children. Keep children away from the product when it is operating. Do not let them tamper with the product.
- Do not allow children sit/climb on or enter in the product.
- Do not forget to close the loading door when leaving the room where the product is located.
- Packaging materials are dangerous

3 Installation

To make the product ready for use, make sure that the electricity and water drainage system are appropriate before installation. If they are not, call a qualified technician and plumber to have any necessary arrangements carried out.

i Preparation of the product's location as well as the electrical and waste water installations is the customer's responsibility.

i Manufacturer shall not be held liable for damages that may arise from procedures carried out by unauthorized persons.

⚠ Prior to installation, visually check if the product has any defects on it. If so, do not have it installed. Damaged products cause risks for your safety.

⚠ The appliance should be transported only in a vertical upright position. If during the course of transport the appliance has to be transported horizontally, it must only be laid on its right hand side. After bringing it to upright position, it must not be operated for at least 12 hours to allow the system to settle. Failure to comply with the above instructions could result in damage occurring to the appliance. The manufacturer will not be held responsible if these instructions are disregarded.

Appropriate installation location

- Install the product on a stable and level surface.
- Dryer is heavy. Do not move it by yourself.
- Operate your product in a well ventilated, dust-free environment.
- Do not block the air ducts in front of and under the product with materials

such as long pile rugs or wooden plinths.

- Do not install the product behind a door with a lock, sliding door or a hinged door which can strike the product.
- Once the product is installed, it should stay at the same place where its connections have been made. When installing the product, make sure that the rear wall of it does not touch anywhere (tap, socket, etc.). Also pay attention to select an installation location which you will not be required to change afterwards.
- Place the product at least 1.5 cm away from the edges of other furniture.
- ⚠** Do not place the product on the power cable.

Removing the transportation safety assembly

- ⚠** Remove the transportation safety assembly before using the product for the first time.
1. Open the loading door.
 2. There is a nylon bag inside the drum that contains a piece of styrofoam. Hold it from its section marked with XX XX.
 3. Pull the nylon towards yourself and remove the transportation safety assembly.

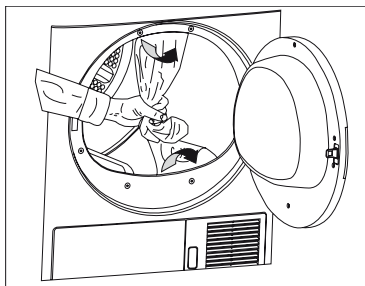

⚠ Make sure that no part of the

transportation safety assembly remains inside the drum.

Under counter installation

- This product can be installed under a counter if the height of the counter is sufficient.

⚠ Never operate the dryer without the top trim is in place.

Dryer Depth	60 cm	54 cm
Stock number of under-bench installation part	2979600100	2973600100

- Leave at least 3 cm of space around the sides and the rear wall of the product when installing it under a counter or in a cupboard.

Mounting over a washing machine

- A fixing device should be used between the two machines when installing the dryer above a washing machine. The fixing device can usually be obtained from a specialist retailer.
- Total weight of the washing machine and the dryer -with full load- when they are placed on top of each other reaches to approx. 180 kilograms. Place the products on a solid floor that has sufficient load carrying capacity!

Connecting to the drain

In products equipped with condenser unit, water accumulates in the water tank during the drying cycle. You should drain accumulated water after each drying cycle.

You can directly drain accumulated water through the water drain hose supplied with the product instead of periodically draining the water collected in the water tank.

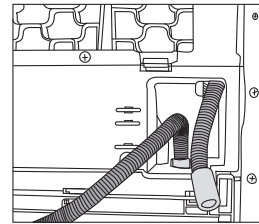
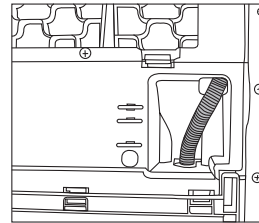

Connecting the water drain hose

1. Pull hose in the product by hand in order to disconnect it from where it is connected. Do not use any tools to remove the hose.
2. Connect one end of the drain hose supplied separately with the product to the connection point from where you removed the hose of the product in previous step.

3. Connect the other end of the drain hose directly to the wastewater drain or to the washbasin.

⚠ Hose must be fixed in every type of connection. Your house will be flooded if the hose comes loose during water discharge.

i Water drain hose should be attached to a height of maximum 80 cm.

i Make sure that the water drain hose is not stepped on and it is not folded between the drain and the machine.

Adjusting the feet

In order to ensure that the product operates more silently and vibration-free, it must stand level and balanced on its feet. Balance the machine by adjusting the feet.

Turn the feet to left or right until the machine stands level and firmly.

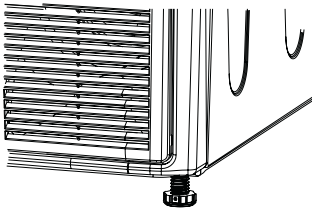

i Never remove the adjustable feet from their housings.

First use

Before starting to use the product, make sure that all preparations are made in accordance with the instructions in sections “Important safety instructions” and “Installation”.

Disposing of packaging material

Packaging materials are dangerous to children. Keep packaging materials in a safe place away from reach of the children.

Packaging materials of the product are manufactured from recyclable materials. Dispose of them properly and sort

in accordance with recycled waste instructions. Do not dispose of them with normal domestic waste.

Transportation of the product

1. Unplug the product before transporting it.
2. Remove the water drain (if any).
3. Drain the water in the product completely.

⚠ We recommend carrying the product in upright position. If it is not possible to carry the machine in the upright position, we recommend carrying it by tilting towards the right side when looked from the front. After the product is moved to its new place, you should wait for 12 hours before starting it.

Disposing of the old product

Dispose of the old product in an environmentally friendly manner. Refer to your local dealer or solid waste collection centre in your area to learn how to dispose of your product.

For children's safety, cut the power cable and break the locking mechanism of the loading door so that it will be nonfunctional before disposing of the product.

Warnings about sounds

i It is normal to hear metallic noise from the compressor sometimes during operation.

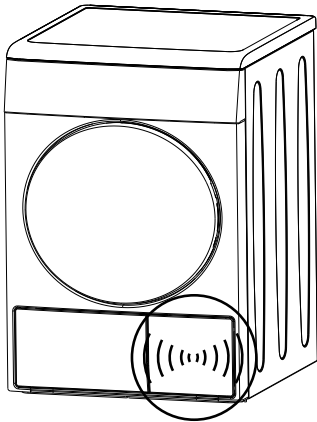

i Water collected during operation is pumped to water tank. It is normal to hear pumping noise during this process.

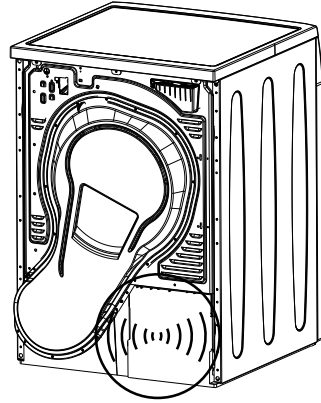

4 Electrical Connection

Make sure that you have an earthed power outlet socket rated at 13 amps (minimum).

Attention!

If you use your dryer as built-in, the socket must be reachable after installation, or a separate switch (which can disconnect the two poles) must be used in the installation. Check for suitability.

For a permanent connection, a master switch with at least 3mm contact clearance and minimum 13 A rating must be used.

Electrical requirements

Before you insert the plug into the wall socket make sure that the voltage and the frequency shown in the rating label corresponds to your electricity supply. We recommend that this appliance be connected to the mains supply via a suitable switched and fused socket in a readily accessible position.

Should the mains lead of the appliance become damaged or need replacing at any time, it must be replaced by a special purpose made mains lead which can only be obtained from a Authorised Service Agent.

Warning

This appliance must be earthed

If the fitted moulded plug is not suitable for your socket, then the plug should be cut off and an appropriate plug fitted. The moulded plug on this appliance incorporates a 13A fuse. Should the fuse need to be replaced an ASTA approved BS1362 fuse of the same rating must be used. Do not forget to refit the fuse cover. In the event of losing the fuse cover, the plug must not be used until a replacement fuse cover has been fitted.

Colour of the replacement fuse cover must be the same colour as that visible on the pin face of the plug. Fuse covers are available from any good electrical store.

In order to avoid hazards, damaged supply cord should be replaced by the manufacturer, its service agent or similarly qualified people.

Important

Fitting a different plug

As the colours of the wires in the mains lead of this appliance may not correspond with the coloured markings identifying the terminals on your plug, proceed as follows:

- 1 Connect the green - yellow or green (earth) wire to the terminal in the plug marked 'E' or with the symbol or coloured green and yellow or green.
- 2 Connect the blue (neutral) wire to the terminal in the plug marked 'N' or coloured black.
- 3 Connect the brown (live) wire to the terminal in the plug marked 'L' or coloured red.

With the alternative plugs a 13A fuse must be fitted either in the plug or adaptor or in the main fuse box. If in doubt contact a qualified electrician.

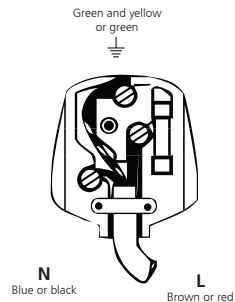

Washer/dryer combination

Do not stack washing machine on top of the tumble dryer. This would damage both appliances and guarantees would become void. It is also unsafe to stack an appliance on top of another without using a suitable and approved stacking kit obtained from specialist retailers.

5 Preparations for drying

Things to be done for energy saving

Following information will help you use the product in an ecological and energy-efficient manner.

- Operate the product at a capacity suitable for the programme you have selected and pay attention not to overload.
- Spin your laundry at the highest speed possible when washing them. Thus, the drying time is shortened and energy consumption is reduced.
- Dry the same type of laundry together.
- Follow the instructions in the user manual for programme selection.
- Leave sufficient clearance at the front and rear side of the dryer for air circulation. Do not block the ventilation grills at the front side of the product.
- Do not open the loading door of the machine during drying unless necessary. If you must certainly open the loading door, do not to keep it open for a long time.
- Do not add new (wet) laundry during drying.
- Lint and fibres released from the laundry to the air during the drying cycle are collected in the Lint Filter. Clean the lint filter before or after each drying cycle.
- Clean the filter drawer regularly either when the Filter Drawer Cleaning warning symbol appears or after every 5 drying cycles
- Ventilate the room, where the dryer is located, well during drying.
- For models with lamp, keep the door closed if the On/Off button is pressed (if the machine is energized) when

machine is not in use.

Laundry suitable for drying in the machine

- **i** Always obey the instructions given on the garment tags. Dry only the laundry having a label stating that they are suitable for drying in a dryer and make sure that you select the appropriate programme.

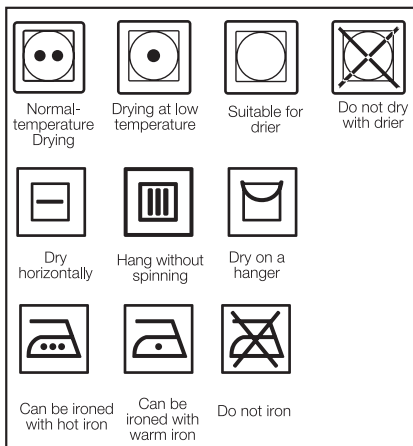

Laundry unsuitable for drying in the machine

- Laundry and items stated below are not suitable for drying in a dryer:
- Laundry items with metal attachments such as metal buttons, metal reinforcements or belt buckles.
- Woollen or silk garments, nylon stockings, delicate embroidered fabrics and sleeping bags.
- Garments made of delicate and valuable fabrics.
- Fine net or voile curtains.
- Items made of hermetic fibres such as pillows and quilts.
- Very wet laundry items.
- Unwashed dirty laundry items.
- Laundry items containing rubber foam or rubber.

⚠ Items cleaned, washed or spotted with gasoil/fuel oil, dry-laundry solvents, industrial chemicals or other combustible or explosive materials should not be dried in the dryer.

⚠ Items soiled with cooking oils, acetone, alcohol, fuel oil, kerosene, stain removers, turpentine, paraffin and paraffin removers must be washed in hot water with plenty of detergent before being dried in the dryer.

Preparing laundry for drying

- Check all garments before loading and make sure that there is no any lighters, coins, metal pieces, needles, and etc. in their pockets or on them.
- Laundry may be tangled after washing. Separate the laundry items before placing them into the dryer.
- Sort the laundry according to their types and thicknesses. Dry the same type of laundry together. For instance, thin kitchen towel and table cloths get dry earlier than the thick bath towels.

i Laundry must be spun at the highest spin speed that the washing machine allows on basis of the fabric type.

Correct load capacity

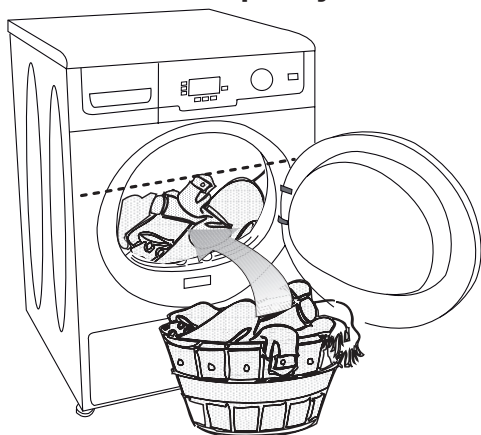

Follow the instructions in the “Programme selection and consumption table”. Do not

load more than the capacity values stated in the table.

i It is not recommended to load the dryer with laundry exceeding the level indicated in the figure. Drying performance will degrade when the machine is overloaded. Furthermore, dryer and the laundry can get damaged.

Following weights are given as examples.

Home articles	Approximate weights (g)
Cotton quit covers (double)	1500
Cotton quit covers (single)	1000
Bed sheets (double)	500
Bed sheets (single)	350
Large tablecloths	700
Small tablecloths	250
Tea napkins	100
Bath towels	700
Hand towels	350
Garments	Approximate weights (g)
Blouses	150
Cotton shirts	300
Shirts	200
Cotton dresses	500
Dresses	350
Jeans	700
Handkerchiefs (10 pieces)	100
T-Shirts	125

Loading the laundry

1. Open the loading door.
 2. Place the laundry in the machine without compressing.
 3. Push the loading door to close.
-  Ensure that no items are caught in the door.

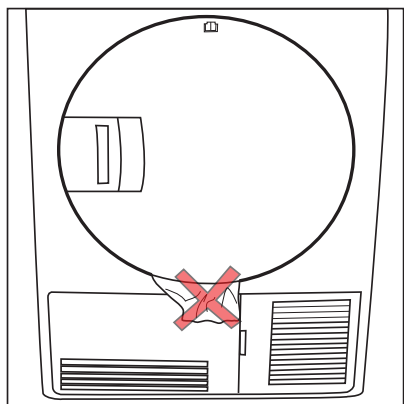
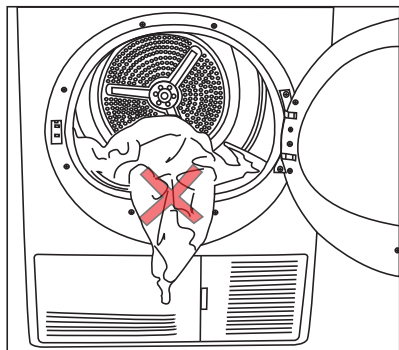

6 Selecting a Programme and Operating Your Machine

Control panel

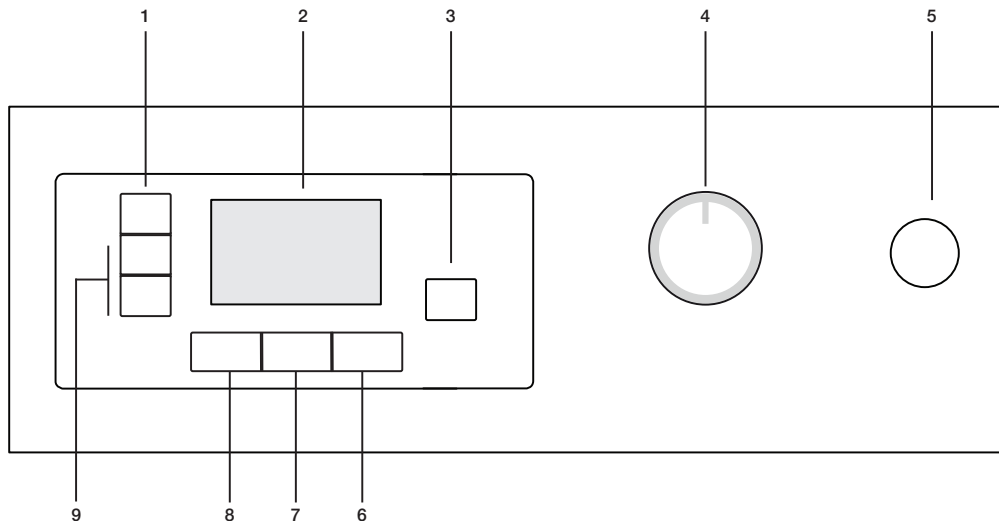

1. Washing Machine Spin Speed / Timer Programme Selection button
2. Display
3. Start / Pause / Cancel button
4. Programme Selection knob
5. On / Off button
6. Anti-creasing button
7. Dryness Level button
8. Cancel Audio Warning button
9. Time Delay buttons

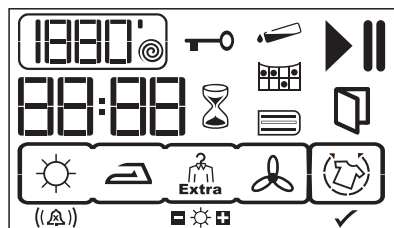

- Spin speed / Timer programmes*
- Operation symbol
- Pause symbol
- Water Tank warning symbol
- Filter cleaning warning symbol
- Filter Drawer Cleaning warning symbol
- Remaining Time indicator**
- Child-proof Lock warning symbol
- Time Delay mode
- Loading door open warning symbol
- Anti-creasing mode
- Audio Warning Level / Cancel Audio Warning
- Dryness Level
- Anti-creasing is activated

* Spin speed is used to show the remaining time more accurately. It does not affect the performance of your machine.

** Time that appears on display indicates the remaining time until the end of the programme and changes according to the dampness level of the laundry.

Preparing the machine

1. Plug in the machine.
 2. Place the laundry in the machine.
 3. Press the On / Off button.
- i** Pressing the On / Off button does not necessarily mean that the programme has started. Press Start / Pause / Cancel button to start the programme.

Programme selection

1. Decide the appropriate programme from the table below which includes drying levels.
2. Select the desired programme with the Programme Selection knob.

Extra Dry	Only the cotton laundry is dried at normal temperature. Thick and multi layered laundry (towels, linens, jeans and etc.) are dried in a way that they do not require ironing before being placed in the wardrobe.
Cupboard dry	Normal laundry (tablecloths, underwear and etc.) are dried in a way that they do not require ironing before being placed in the wardrobe.
Iron Dry	Normal laundry (shirts, dresses and etc.) are dried ready to be ironed.

- i** For further programme details, see "Programme selection and consumption table".

Main programmes

Depending on the fabric type, the following main programmes are available:

• Cottons

Dry durable laundry with this programme. Dries at normal temperature. It is recommended to use for your cotton items (bed sheets, quilt covers, towels,

bathrobes, etc.).

• Synthetics

Dry less durable laundry with this programme. Recommended for synthetics.

Additional programmes

For special cases, following additional programmes are available in the machine.

- i** Additional programmes may differ according to the features of your machine.

• Xpress 1kg

You can use this programme to dry your cotton laundry that you have spun at high speeds in your washing machine. This programme dries 1 kg cotton laundry (3 Shirts/3 T-shirts) in 45 minutes.

- i** To obtain better results from your dryer, your laundry must be washed at suitable programmes and spun at the recommended speed in the washing machine.

• Shirts

This programme dries the shirts more sensitively and creases them less and thus, helps to iron them more easily.

- i** There may be a little moisture on the shirts at the end of the programme. We recommend you not to leave the shirts in the dryer.

• Jeans

Use this programme to dry your jeans that are spun at high speeds in the washing machine.

• Mix

Use this programme to dry colour-fast synthetic and cotton laundry items together.

• Sportswear

Use this programme to dry together the synthetic and cotton laundry items and the laundry items made of mixed fabrics.

• Woollens care

You can use this programme to ventilate

and soften your woollen laundry that can be washed in the washing machine. Do not use this programme to dry your laundry completely. Take out your laundry and ventilate them immediately after the programme is over.

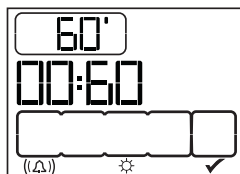

- **Daily Quick**

This programme is used to dry cottons and synthetics daily, and lasts for 1.5 hour.

- **Baby Clothing**

This programme is used for baby clothes that bear machine dryable approval on its label.

- **Delicates**

You can dry your highly delicate laundry that are suitable for drying or laundry which is advised to be hand-washed at a lower temperature.

i It is recommended to use a cloth bag to prevent certain delicate laundry from getting creased or damaged. Take your laundry immediately out of the dryer and hang them after the programme is over in order to prevent them from getting creased.

- **Freshen up**

Only ventilation is performed for 10 minutes without blowing hot air. You can air the clothes that have been kept at closed environments for a long time and deodourise unpleasant odours thanks to this programme.





- **Timer programmes**

You can select one of the 10 min., 20 min., 30 min., 40 min., 50 min., 60 min., 80 min., 100 min., 120 min., 140 min. and 160 min. timer programmes to achieve the desired final drying level at low temperatures.

i With this programme, the machine dries for the time selected regardless of the dryness level.

Programme selection and consumption table

EN

Programmes	Capacity (kg)	Spin speed in washing machine (rpm)	Approximate amount of remaining humidity	Drying time (minutes)
Cottons / Coloureds				
 Extra dry	8	1000	60 %	190
 Cupboard dry	8	1000	60 %	175
 Iron dry	8	1000	60 %	150
Baby Clothing	3	1000	60 %	80
Shirts	1.5	1200	50 %	50
Jeans	4	1200	50 %	120
Daily Quick	4	1200	50 %	90
Mix	4	1000	60 %	115
Sportswear	4	1000	60 %	105
Xpress 1kg	1	1200	50 %	45
Delicates	2	600	40 %	55
Woollens care	1.5	600	50 %	8
Synthetics				
 Cupboard dry	4	800	40 %	70
 Iron dry	4	800	40 %	55
Energy consumption values				
Programmes	Capacity (kg)	Spin speed in washing machine (rpm)	Approximate amount of remaining humidity	Energy consumption value kWh
Cottons linen Ready to wear*	8	1000	60 %	2,68
Cottons Ready to iron	8	1000	60 %	2,1
Synthetics Ready to wear	4	800	40 %	0,95

* : Energy Label standard programme (EN 61121:2005)

All values given in the table have been fixed according to EN 61121:2005 Standard. These values may deviate from the values in the table according to the laundry type, laundry spin speed, environmental conditions and voltage fluctuations.

Auxiliary functions

Audio Warning

The machine will give an audio warning when the programme comes to an end. If you do not want the machine to give an audio warning, press the Volume Level button repeatedly until "x" appears on the display. Use the same button to adjust the volume level.

i You can activate this function either before or after the programme starts.



Dryness level

Used to adjust the required dryness level. More drying is performed compared to the default settings when "+" sign appears and less drying is performed when "-" sign appears. Programme duration can change depending on the selection.

i You can activate this function only before the programme has started.



Anti-creasing

You can use Anti-creasing function to prevent laundry from creasing if you will not take the laundry out after the programme has come to an end. This programme rotates the laundry in every 240 second for 2 hours to prevent creasing.

Anti-creasing is activated but the programme is still running in the first display image below. Drying cycle is completed and the Anti-creasing step has started in the second display image.

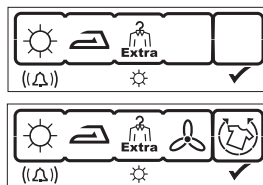

i Press Anti-creasing button to activate this function.

Changing the contrast

Adjust the display contrast in order to make the symbols on the display appear clearer. It may particularly be necessary to change the contrast setting of the display when the dryer is installed over a washing machine.

Press and hold the Spin Speed / Timer Programme button for 3 seconds. When the contrast is changed, all symbols on the display will appear for 3 seconds in order to indicate that the process is complete.

i Perform the same procedure to revert back to the previous contrast setting.

Warning symbols

i Warning symbols may differ according to the model of your machine.

Lint filter cleaning

When the programme is completed, a warning symbol will appear to remind that the filter needs to be cleaned.

i If the Filter Cleaning symbol flashes continuously, refer to "Troubleshooting" section.

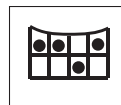

Water tank

When the programme is completed, a warning symbol will appear to remind that the water tank needs to be drained. If the water tank becomes full while the programme is running, the warning

symbol will start to flash and machine will pause. Drain the water in the water tank and press Start / Pause / Cancel button to resume the programme. The warning symbol turns off and the programme resumes operating.



Cleaning of filter drawer

Warning symbol flashes with certain intervals to remind that the filter drawer needs to be cleaned.



Loading door open

This warning symbol appears when the loading door of the dryer is open.



Time Delay

Time Delay function allows you to delay the startup of the programme up to 24 hours.

1. Open the loading door and put the laundry in.
2. Select the drying programme, spin speed and, if required, the auxiliary functions.
3. Press Time Delay buttons + and - to set the desired time delay. The Time Delay symbol will flash.
4. Press Start / Pause / Cancel button. The Time Delay starts to count down. The Time Delay symbol lights up. Start symbol appears. The “:” in the middle of the displayed delay time will start flashing.

i Additional laundry may be loaded / taken out during the Time Delay

period. At the end of the Time Delay countdown process, Time Delay symbol disappears, drying process starts and the programme duration is displayed. The time on the display is the total of normal drying time and delay time.

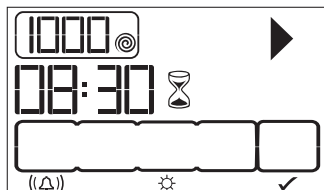

Time Delay is activated by pressing the Start / Pause / Cancel button in the above display image.

Changing the delay time

If you want to change the time during countdown:

1. Press Start / Pause / Cancel button for 3 seconds to cancel the programme. Repeat the Time Delay procedure for the desired time.
2. Set the desired delay time with Time Delay + and - buttons. The Time Delay symbol will flash.
3. Press Start / Pause / Cancel button. The Time Delay starts to count down. The Time Delay symbol lights up. Pause symbol disappears. Start symbol appears.
4. The “:” in the middle of the displayed delay time will start flashing.

Cancelling the Time Delay

If you want to cancel the Time Delay countdown and start the programme immediately:

1. Press Start / Pause / Cancel button for 3 seconds to cancel the programme.
2. Press Start / Pause / Cancel button to start the programme you have previously selected.

Starting the programme

Press Start / Pause / Cancel button to start the programme.

Start / Pause symbol will light up to indicate that the programme has started and ":" symbol between the remaining time will continue flashing.

Progress of programme

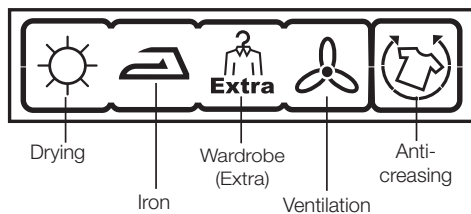

Progress of a running programme is indicated on the display by means of a set of symbols.

At the beginning of each programme step, the relevant symbol in the series of symbols will light up and thus, at the end of the programme, all symbols will remain lit up. The rightmost symbol on the display indicates the step being carried out.

Drying

Drying symbol lights up in all programmes apart from ventilation.

Iron Dry

Starts to illuminate when the dryness level reach Iron Dry step.

Wardrobe Dry

Starts to illuminate when the dryness level reach Wardrobe Dry step.

Wardrobe Dry Extra

Starts to illuminate when the dryness level reach Wardrobe Dry Extra step.

Ventilation

Ventilation symbol illuminates when the programme comes to an end.

i Anti-creasing symbol will illuminate at the end of the programme if Anti-creasing function is activated.

Child-proof Lock

Machine is equipped with a Childproof Lock which prevents interfering with the current programme flow by pressing any button. All buttons except the On / Off button on the control panel are deactivated when the Child-proof Lock is active.

In order to activate the Childproof Lock, press Audio Warning and Anti-Creasing buttons simultaneously for 3 seconds. To start a new programme after the current programme is over or to interrupt the current programme, the Child-proof Lock should be deactivated. Press the same buttons for 3 seconds again to deactivate the Child-proof Lock.

i Lock symbol will appear on the display when the Child-proof Lock is activated.

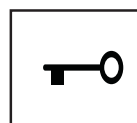

i Child-proof Lock is deactivated when the machine is switched off and on with On / Off button.

When the Child-proof Lock is activated:

- Display symbols will not change even if the position of Programme Selection knob is changed while the machine is running or in halt.
- If the Child-proof Lock is deactivated after changing the position of the Programme Selection knob while the machine is running, the machine stops and new programme information is displayed.

Changing the programme after it has started

After the machine starts, you can change the selected programme and dry your laundry in a different programme.

1. If you want to select Extra Dry

programme instead of Iron Dry programme, press and hold the Start / Pause / Cancel button for 3 seconds to cancel the programme.

2. Select Extra Dry programme by turning the Programme Selection knob.
3. Press Start / Pause / Cancel button to start the programme.

i You can also select a new programme by turning the Programme Selection knob while the machine is operating. In this case, current programme is aborted and the new programme information appears on the display.

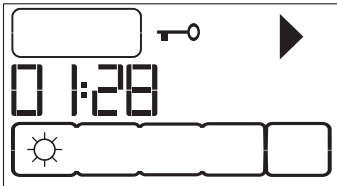

Adding / removing laundry in Pause mode

In order to add or take out laundry after the drying programme has started:

1. Press Start / Pause / Cancel button to switch the machine to Pause mode. Drying process will stop.
2. While in Pause mode, open the loading door, add or take out laundry and close the loading door.
3. Press Start / Pause / Cancel button to start the programme.

i Any laundry added after the drying process has started may cause the clothes that are already dried in the machine intermingle with wet clothes and the result will be wet laundry after the drying process is over.

i You may repeat laundry adding or removing process as many times as you desire during drying. However, this process will increase

the programme time and energy consumption since the drying process will be interrupted repeatedly. Therefore, it is recommended to add laundry before the drying programme has started.

i If you select a new programme by turning the Programme Selection knob while your machine is in Pause mode, then the current programme is aborted and new programme information is displayed.

⚠ Do not touch the inner surface of the drum when adding or taking out laundry while a programme is running. Surfaces of the drum are hot.

Cancelling the programme

If you want to stop drying and cancel the programme for any reason after the machine has started to run, press and hold the Start / Pause / Cancel button for 3 seconds. Lint Filter Cleaning and Water Tank warning symbols light up and "End" label appears on the display as a reminder at the end of this period.

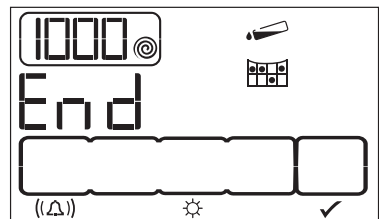

⚠ As the inside of the machine will be excessively hot when you cancel the programme while the machine is running, activate the ventilation programme to cool it down.

i Machine will stop if you turn the Programme Selection knob while it is operating. In this case, current programme is aborted and the new programme information appears on the display.

End of programme

Lint Filter Cleaning and Water Tank warning symbols light up in the programme follow-up indicator and "End" label appears on the display when the programme comes to an end. The loading door can be opened and the machine becomes ready for a second cycle.

Press On / Off button to switch off the machine.

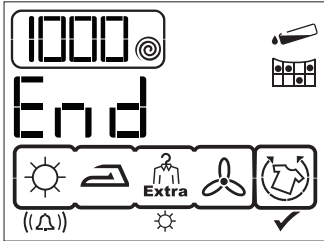

- i** If Anti-creasing function is activated and the laundry is not taken from the machine at the end of the programme, 2-hours Anti-creasing programme is activated.
- i** Clean the lint filter after each drying. (See "Lint Filter / Loading Door Inner Surface")
- i** Drain the water tank after each drying cycle. (See "Draining the water tank")

7 Maintenance and cleaning

Service life of the product extends and frequently faced problems decrease if cleaned at regular intervals.

⚠ This product must be unplugged during maintenance and cleaning works (control panel, body, etc.).

Lint Filter / Loading Door Inner Surface

Lint and fibres released from the laundry to the air during the drying cycle are collected in the Lint Filter.

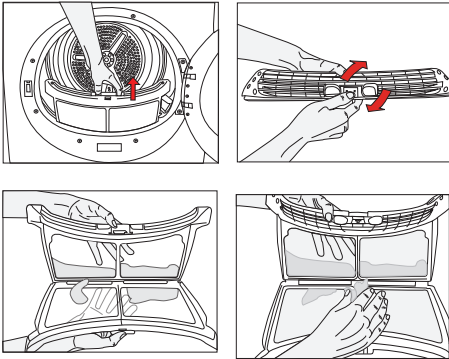

i *Such fibre and lint are generally formed during wearing and washing.

⚠ Always clean the lint filter and the inner surfaces of the loading door after each drying process.

i You can carefully clean the lint filter housing with a vacuum cleaner.

To clean the lint filter:

1. Open the loading door.
2. Remove the lint filter by pulling it up and open the lint filter.
3. Clean lint, fibre, and cotton by hand or with a soft piece of cloth.
4. Close the lint filter and place it back into its housing.

i A layer can build up on the lint filter pores that can cause clogging of the lint filter after using the machine for a while. Wash the lint filter with warm water to remove the layer that builds

up on the lint filter surface. Dry the lint filter completely before reinstalling it.

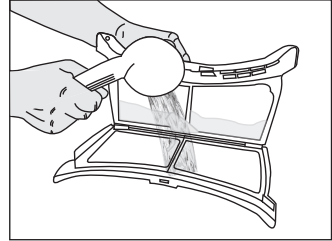

i Clean the entire inner surface of the loading door and loading door gasket with a damp cloth.

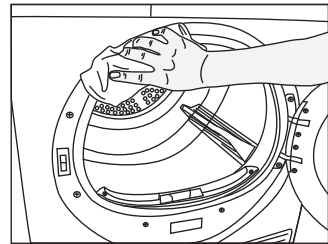
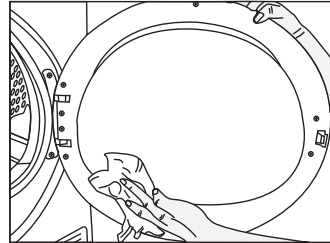

Cleaning the sensors

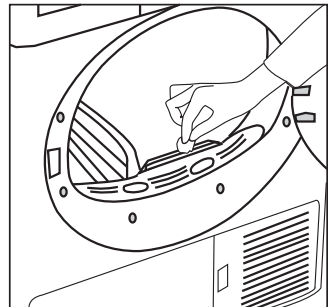

There are dampness sensors in the machine that detect whether the laundry is dry or not.

To clean the sensors:

1. Open the loading door of the machine.
2. Allow the machine to cool down if it is still hot due to the drying process.
3. Wipe the metal surfaces of the sensor with a soft cloth, dampened with vinegar and dry them.

i Clean metal surfaces of the sensors 4 times a year.

i Do not use metal tools when cleaning metal surfaces of the sensors.

! Never use solvents, cleaning agents or similar substances for cleaning due to the risk of fire and explosion!

Draining the water tank

Dampness of the laundry is removed and condensed during drying process and the water formed accumulates in the water tank. Drain the water tank after each drying cycle.

! Condensed water is not drinkable!

! Never remove the water tank when the programme is running!

If you forget to drain the water tank, the machine will stop during the subsequent drying cycles when the water tank is full and the Water Tank warning symbol will flash. If this is the case, drain the water tank and press Start / Pause / Cancel button to resume the drying cycle.

To drain the water tank:

1. Pull the drawer and remove the water tank carefully.

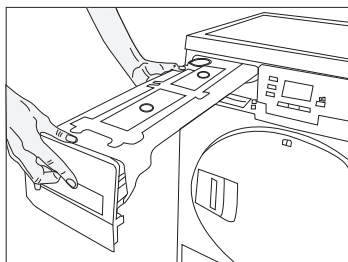

2. Drain the water in the tank.

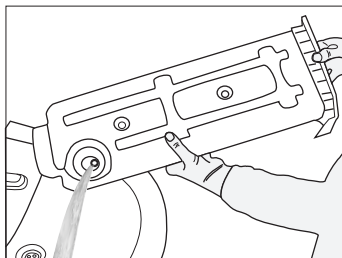

3. If there is lint accumulation in the funnel of the water tank, clean it under running water.
4. Place the water tank into its seat.

Cleaning the filter drawer

Lint and fibre that could not be captured by the lint filter are blocked in the filter drawer behind the kick plate. Filter Drawer Cleaning warning light will light up maximum at every 5 drying cycles as a reminder.

There is a two-level filter in the filter drawer. The first level is the filter drawer sponge and the second level is the filter cloth.

To clean the filter drawer:

1. Press the kick plate button to open the kick plate.

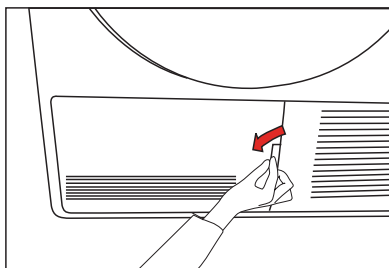

2. Remove the filter drawer cover by turning it in the direction of arrow.

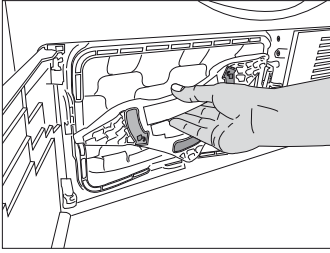

3. Pull out the filter drawer.

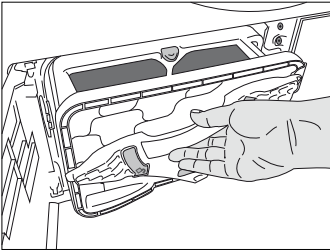

4. Open the filter drawer by pressing the red button.

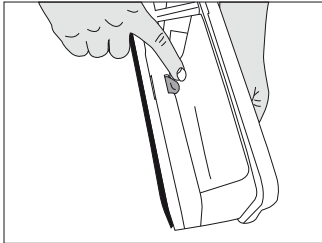

5. Take out the filter drawer sponge.

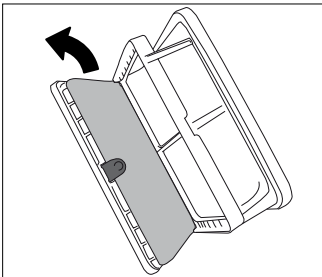

6. Clean lint, fibre, and cotton from the filter cloth by hand or with a soft piece of cloth.

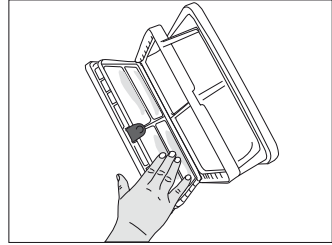

- i** When you notice a layer that may lead to clogging on filter cloth, please clean the layer by washing in warm water. Let the filter cloth dry thoroughly before installing back the filter drawer.

7. Hand-wash the filter drawer's sponge to remove hair and lint on it. Squeeze the sponge by hand to remove excessive water.

- i** It is not necessary to clean the sponge if lint and fibre accumulation on it is not significant.

8. Place the sponge back into its place.

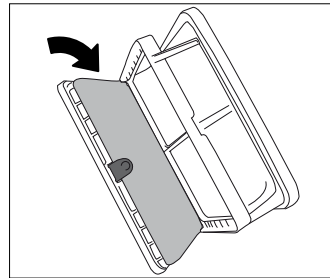

9. Close the filter drawer as to lock the red button.

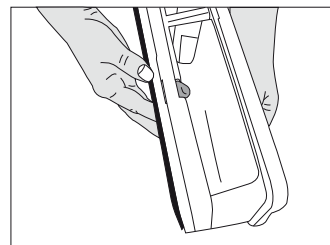

10. Place the filter drawer back into its place, turn the filter drawer cover clockwise making sure that it is closed securely.

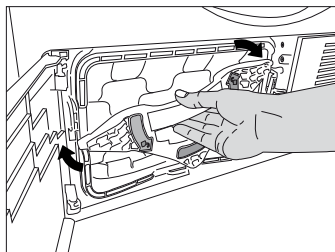

11. Close the kick plate cover.

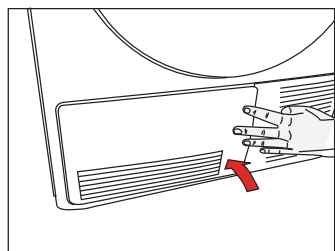

- i** Drying without the filter drawer sponge in place will damage the machine!
- i** A dirty lint filter and filter drawer will cause longer drying periods and higher energy consumption.
- i** A layer can build up on the lint filter pores that can cause clogging of the lint filter after using your machine for a while. Wash the lint filter with warm water to remove the layer that builds up on the lint filter surface. Dry the lint filter completely before using it.

Cleaning the evaporator

Carefully clean the lints accumulated on the fins of the evaporator located behind the filter drawer with a vacuum cleaner.

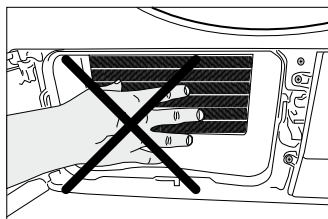

- i** You can also clean by hand provided that you wear protective gloves. Do not attempt to clean with bare hands.

8 Troubleshooting

Drying process takes too much time.

- Pores of the lint filter are clogged. >>> *Wash the lint filter with warm water.*
- Filter drawer is clogged. >>> *Clean the sponge and the filter cloth in the filter drawer.*
- Ventilation grids on the front side of the machine are blocked. >>> *Remove the objects (if any) that block ventilation in front of the ventilation grids.*
- Ventilation is not sufficient since the room where the machine is installed is very small. >>> *Open the door and window of the room to avoid the room temperature increase too much.*
- Lime deposit has built up on the dampness sensor. >>> *Clean the dampness sensor.*
- Excessive laundry is loaded. >>> *Do not load the dryer in excess.*
- Laundry is not spun sufficiently. >>> *Spin your laundry at a higher speed in your washing machine.*

Laundry comes out wet at the end of drying.

- i** After drying, the hot clothes feel damper than their actual dampness level.
 - It is likely that the selected programme did not suit the laundry type.>>>*Checking the care labels on clothes, select appropriate programme for the laundry type or use timer programmes in addition.*
 - Pores of the lint filter are clogged. >>> *Wash the lint filter with warm water.*
 - Filter drawer is clogged. >>> *Clean the sponge and the filter cloth in the filter drawer.*
 - Excessive laundry is loaded. >>> *Do not load the dryer in excess.*
 - Laundry is not spun sufficiently. >>> *Spin your laundry at a higher speed in your washing machine.*

Dryer does not switch on or the programme does not start. Dryer does not start when it is set.

- It is not plugged in. >>> *Make sure that the machine is plugged in.*
- The loading door is ajar. >>> *Make sure that the loading door is closed securely.*
- Programme is not selected or the Start / Pause / Cancel button is not pressed. >>> *Make sure that the programme is selected and the machine is not in Pause mode.*
- Childproof Lock is activated. >>> *Deactivate the Childproof Lock.*

Programme is interrupted without any cause.

- Loading door is ajar. >>> *Make sure that the loading door is closed securely.*
- There was a power failure. >>> *Press Start / Pause / Cancel button to start the programme.*
- Water tank is full. >>> *Drain the water tank.*

Laundry has shrunk, become felted or deteriorated.

- A programme suitable for the laundry type is not used. >>> *Check the garment tag and select a programme suitable for the fabric type.*

Drum lighting does not turn on. (On models with lamp)
<ul style="list-style-type: none"> • Dryer is not switched on with the On / Off button. >>> <i>Make sure that the dryer is switched on.</i> • Lamp is defective. >>> <i>Call Authorized Service Agent to have the lamp replaced.</i>
End/Anti-creasing symbol is on.
<ul style="list-style-type: none"> • Anti-creasing programme is activated in order to prevent laundry that has remained in the machine from creasing. >>> <i>Turn off the dryer and take out the laundry.</i>
End symbol is on.
<ul style="list-style-type: none"> • Programme is over. Turn off the dryer and take out the laundry.
Lint Filter Cleaning symbol is on.
<ul style="list-style-type: none"> • Lint filter is not cleaned. >>> <i>Clean the lint filter.</i>
Lint Filter Cleaning symbol is flashing.
<ul style="list-style-type: none"> • Filter housing is clogged with lints. >>> <i>Clean the lint filter housing.</i> • A deposit has built up on the lint filter pores that may cause clogging. >>> <i>Wash the lint filter with warm water.</i> • Filter drawer is clogged. >>> <i>Clean the sponge and the filter cloth in the filter drawer.</i>
Water leaks from the loading door
<ul style="list-style-type: none"> • Lint has accumulated on the inner surfaces of the loading door and on the surfaces of the loading door gasket. >>> <i>Clean the inner surfaces of the loading door and the surfaces of the loading door gasket.</i>
Loading door opens spontaneously.
<ul style="list-style-type: none"> • Loading door is ajar. >>> <i>Push the loading door to close until you hear a locking sound.</i>
Water Tank warning symbol is on/flashing.
<ul style="list-style-type: none"> • Water tank is full. >>> <i>Drain the water tank.</i> • Water draining hose is bent. >>> <i>If the product is connected directly to a wastewater drain, check the water drain hose.</i>
Filter Drawer Cleaning warning symbol is flashing.
<ul style="list-style-type: none"> • Filter drawer is not cleaned. >>> <i>Clean the sponge and the filter cloth in the filter drawer.</i>

 If you cannot eliminate the problem although you follow the instructions in this section, consult your dealer or the Authorized Service Agent. Never try to repair a nonfunctional product yourself.

9 Guarantee

Your new product is guaranteed against the cost of breakdown repairs for twelve months from the date of the original purchase.

What is covered?

- Repairs necessary as a result of faulty materials, defective components or manufacturing defect.
- The cost of functional replacement parts, but excluding consumable items.
- The labour costs of a approved repairer to carry out the repair.

What is not covered?

- Transit, delivery or accidental damage or misuse and abuse.
- Cabinet or appearance parts, including knobs, flaps, handles or container lids.
- Accessories or consumable items including but not limited to, ice trays, scrapers, cutlery baskets, filters and light bulbs.
- Repairs required as a result of unauthorised repair or inexperienced installation that fails to meet the requirements contained in the user instruction book.
- Repairs to products used on commercial or non-residential household premises.
- Loss of frozen food in freezers or fridge/freezers. (Food loss insurance is often included within your household contents insurance policy, or may be available separately from your retailer).

Important notes

- Your product is designed and built for domestic household use only.
- The guarantee will be void if the product is installed or used in commercial or non-residential domestic household premises.
- The product must be correctly installed, located and operated in accordance with the instructions contained in the User Instructions Booklet provided.
- Professional installation by a qualified Electrical Domestic Appliance Installer is recommended for all Washing Machines, Tumble Dryers, Dishwashers, Dryers and Electric Cookers
- Gas Cookers must only be installed by a Gas safe registered Gas Installer.
- The guarantee is given only within the boundaries of the United Kingdom and the Republic of Ireland.
- The guarantee is applicable only to new products and is not transferable if the product is resold.
- Disclaims any liability for incidental or consequential damages.
- The guarantee does not in anyway diminish your statutory or legal rights.

10 Service

Please keep your purchase receipt or other proof of purchase in a safe place; you will need to have it should the product require attention under guarantee.

You should also complete the details below; it will help us assist you when requesting service. (The model number is printed on the Instruction Booklet and the serial number is printed on the Rating Label affixed to the appliance)

Model No:

Serial No:

Retailer:

Date of purchase:

UK Mainland & Northern Ireland

Fridges & Freezers 0845 600 4903

Electric Cookers 0845 600 4902

Gas & Dual Fuel Cookers

0845 600 4905

Washing Machines & Tumble Dryers

0845 600 4906

Republic of Ireland

All Refrigeration, 01 862 3411

All Cookers

Washing Machines & Dryers, Tumble Dryers Dishwashers

Before requesting service please check the trouble-shooting guide in the Operating Instructions as a charge may be levied where no fault is found even though your product may still be under guarantee.

Service once the manufacturers guarantee has expired.

If you have purchased an extended guarantee please refer to the instructions contained within the extended guarantee agreement document. Otherwise please call the appropriate number above where service can be obtained at a charge. Should you experience any difficulty in obtaining service please contact the Customer Help-Line.

Tel: 0845 600 4911

For service under guarantee simply telephone the appropriate number below.

BEKO



BEKO

**Beko plc Beko House, Caxton Way, Watford
Hertfordshire, WD18 8UF**

Tel: 0845 6004911

Fax: 0845 6004922

Email: service@beko.co.uk

www.beko.co.uk